

# KOMATSU®

## PC130-7

**PC**  
**130**

**FLYWHEEL HORSEPOWER**  
Net: 66 kW 89 HP / 2200 min<sup>-1</sup>

**OPERATING WEIGHT**  
12.6 - 12.8T

**BUCKET CAPACITY (SAE)**  
0.53 m<sup>3</sup> - 0.70 m<sup>3</sup>



Photos may include optional equipment.

### Excellent Reliability and Durability

- High rigidity work equipment including cast end boom top
- Sturdy frame structure
- Reliable Komatsu-manufactured major components

See page 4.

### KOMTRAX

#### Information and Communication Technology

- KOMTRAX™ website to optimise your maintenance planning and fleet management

See page 7.

#### Comfortable Cab

- Low vibration with cab damper mounting
- Operator seat and console with armrest that enables operations in the appropriate posture
- Low - noise cabin

See page 6.





## PC130 - Long Arm

Long arm variant with a maximum digging depth of 5520mm

## Easy Machine Management

- Long replacement intervals of oils & filters
- Remote mounted engine oil filter, main fuel filter and drain valve for easy access
- Advanced Self-Diagnostic Monitor facilitating easy service monitoring
- Continuous Machine Monitoring System

See page 8.

## Unmatched Productivity

- Powered by heavy duty Komatsu SAA4D95LE-3 diesel engine
- Active mode for fast cycle times & faster production
- Advanced CLSS hydraulics for fine control and quick working speeds
- Two Boom Setting: Smooth & Power modes can be toggled to change the operation depending on the application

- High mobility due to better drawbar pull

See pages 4 & 5.



---

**HORSEPOWER** Net: 66 kW 89 HP / 2200 min<sup>-1</sup>

---

**OPERATING WEIGHT** 12.6 - 12.8T

---

**BUCKET CAPACITY (SAE)** 0.53 m<sup>3</sup> - 0.70 m<sup>3</sup>

---

## High Production and Low Fuel Consumption

Komatsu PC130-7 gets its exceptional power and work capacity from a Komatsu SAA4D95LE-3 engine. Output is 89 HP/66 kW, providing increased hydraulic power and improved fuel efficiency. The increased output and fuel savings of the Komatsu SAA4D95LE-3 engine result in improved production per unit of fuel.

## Working Mode Selection

Working Mode	Application	Advantage
A	Active Mode	Maximum production/power Fast Cycle times
E	Economy Mode	Excellent Fuel Economy
B	Breaker Mode	Optimum engine rpm, hydraulic flow
L	Lifting Mode	Hydraulic pressure has been increased by 7%

Komatsu PC130-7 excavator is equipped with four working modes (A, E, B and L modes). Each mode is designed to match engine speed, pump speed and system pressure with the current application. This provides the flexibility to match equipment performance to the job at hand.

## Sturdy Frame Structure



The revolving frame, centre frame and undercarriage are designed by using advanced three dimensional CAD and FEM analysis technology.

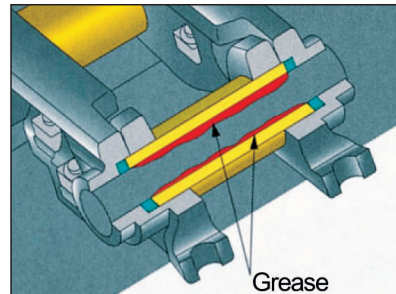

## Grease sealed track

Komatsu PC130-7 uses grease sealed tracks for extended undercarriage life.

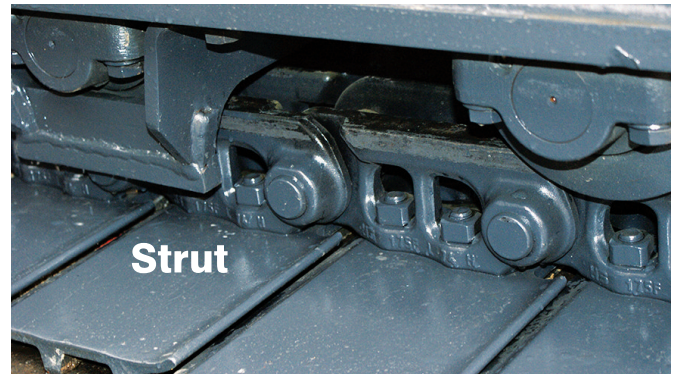

## Track Link with Strut

Komatsu PC130-7 uses track links with strut providing superb durability.

## Reliable Components

All the major machine components, such as engine, hydraulic pump, hydraulic motors and control valves are exclusively designed and manufactured by Komatsu. This guarantees that each component is exclusively built for the class and model of machine. This ensures that the engineering, manufacturing standards and testing that go into each component are totally Komatsu.

## Highly Reliable Electronic Devices

Exclusively designed electronic devices have passed severe testing.

- Controller
- Sensors
- Connectors
- Heat resistant wiring

Metal Guard Rings protect all the hydraulic cylinders and improve reliability.



# ADVANCED HYDRAULICS

## What is HydraMind?

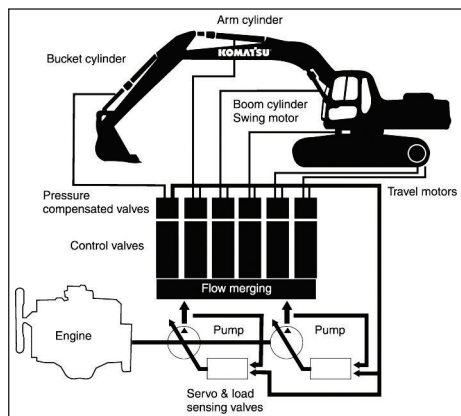

It's a technologically complex yet mechanically simple system which supervises the work operations of the excavator. Its strength lies in its simplicity.

The system incorporates major breakthroughs and has earned Komatsu almost 200 patents.

## What are the benefits of HydraMind?

Power, versatility, manoeuvrability, controllability – you name it. Never has an excavator been so easy to operate, so natural, so intuitive. In a sense, you don't really operate it at all, you wear it.

For example, when the ground condition changes in digging...

You don't have to think about changing your lever strokes because HydraMind instantly, silently, automatically sends just the right amount of oil to the actuators at just the right pressure to accommodate the change.

When you move the boom, arm and bucket at the same time...

All the equipment work organically with the optimum combination of speed and power as if it were a human hand. The HydraMind system also makes it easy to change or add valves and work equipment. Moreover,

because the system is hydraulic and not electronic, it ensures the best service availability in the industry.

## The HydraMind System Makes Everything Easier

### It is easier to fully load the bucket

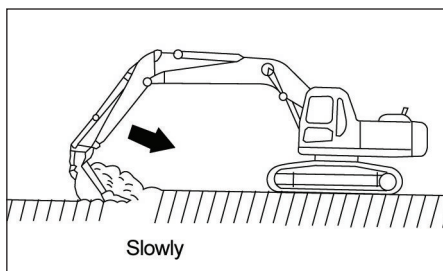

During simultaneous operations, the work equipment moves slowly at maximum power, without being influenced by the other actuators, so it is easy to fully load the bucket.

### It is easy to carry out digging work along the face of walls

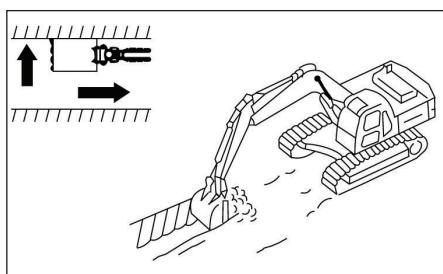

Lateral power pushing is powerful, allowing digging operation to be carried out efficiently.

### The machine can carry out operations easily without undue chassis vibration

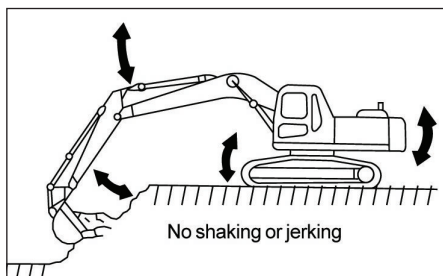

During simultaneous operations, there is no change in the work equipment speed caused by change in load. Thus, there is minimal chassis vibration.

### It is easy to scrape down

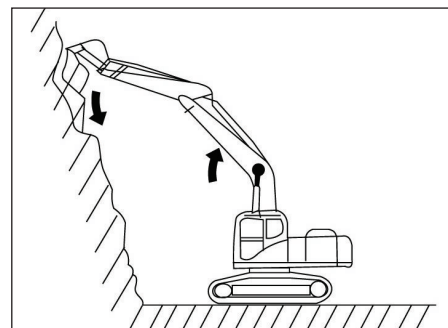

Even without operating the lever to the maximum position, maximum digging power can be obtained, making it possible to carry out slow control.

### It is easy to dig soft rock or dig up boulders

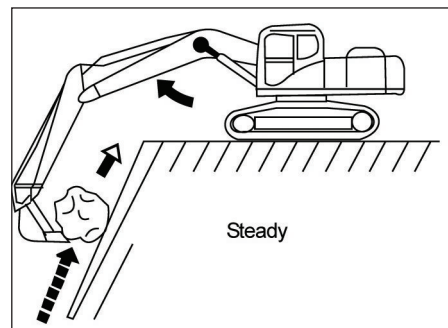

It is easy to control the boom RAISE, so the cutting edge does not deviate from the boulders

# COMFORT



## Adjustable Seat and Control Levers

The seat slides forward and backward together with the work equipment control levers to ensure the best operating position at all times.

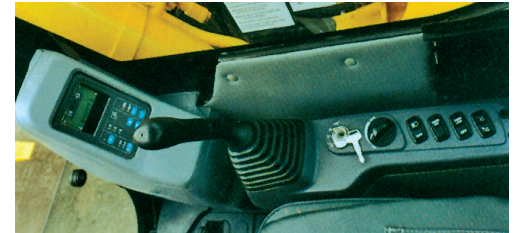

## Lock lever

Locks the hydraulic pressure to prevent unintentional movement. Neutral start function only allows the machine to be started in lock position.



## Spacious Cab Interior

The cab interior is spacious. An ergonomically-designed operator's seat and slide mechanism allows the operator to position the controllers for maximum productivity and comfort.

## Low vibration with cab damper mounting

A multi-layer viscous mount system incorporates a long stroke along with a spring. The new cab damper mounting combined with a high rigidity deck reduces vibration at the operator's seat.

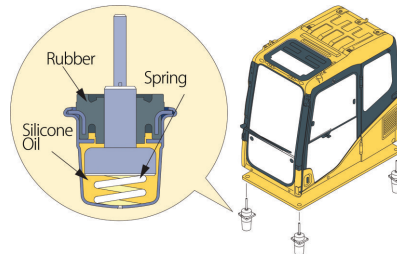

## Protective Guards

Thermal guard placed around high temperature parts of the engine provides adequate protection against accidental contacts, while the fan guard wards off impending hazards.

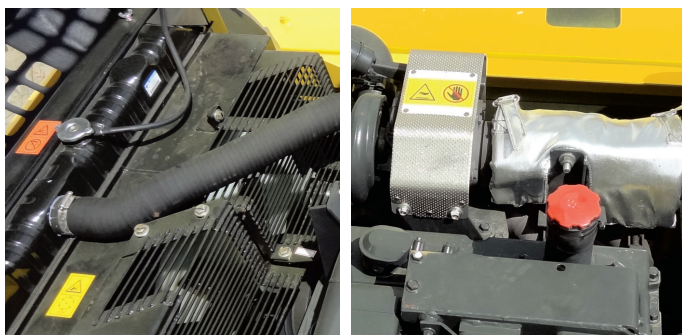

## Skid-Proof Surface

The steps with its skid-proof surface provide safer grip while on the machine for maintenance and servicing.





**KOMTRAX**

KOMTRAX™ is a revolutionary machine tracking system designed to save your time and money. You can now monitor your equipment anytime and anywhere. Use valuable machine data received via the KOMTRAX™ website to optimise your maintenance planning and fleet management.

**KOMTRAX™ assists you with:**

- **Full machine monitoring**  
Get detailed operation data to know when your machines are used
- **Total fleet management**  
Keep track of the location of your machines at all times and discourage unauthorized usage
- **Easy access to machine information**  
Machine working details can be easily obtained from anywhere using internet facility

**Monitor your machine from anywhere, anytime for complete peace of mind!**

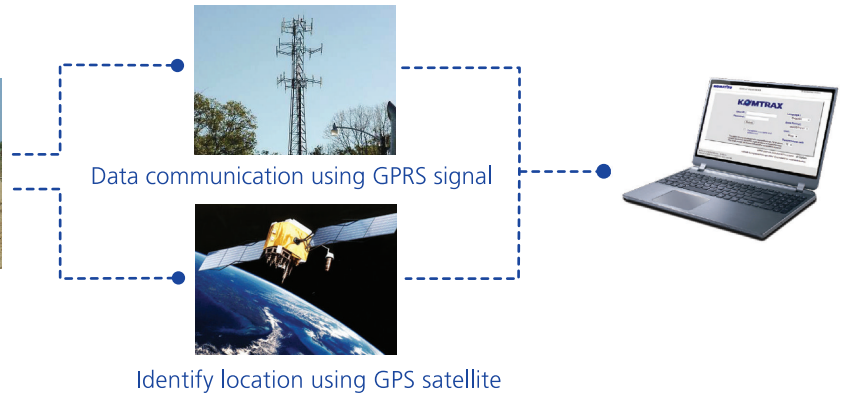

**Summary – Location / SMR / Working**

Summary - Location/SMR/Working

**Working hour record**

Date	Working Status	Working Hour
14/04/2015	00:00 06:00 12:00 18:00 24:00	9.0 H
13/04/2015	00:00 06:00 12:00 18:00 24:00	8.2 H
12/04/2015	00:00 06:00 12:00 18:00 24:00	5.7 H
11/04/2015	00:00 06:00 12:00 18:00 24:00	7.5 H
10/04/2015	00:00 06:00 12:00 18:00 24:00	0.0 H
09/04/2015	00:00 06:00 12:00 18:00 24:00	0.0 H
08/04/2015	00:00 06:00 12:00 18:00 24:00	0.0 H
07/04/2015	00:00 06:00 12:00 18:00 24:00	6.8 H

**Machine location record**

No.	Event	Event Time	GPS Time	LAT.	LONG.
1	Daily Data	04/16/2015 01:34:23	04/16/2015 01:34:23	N11.20.17.225	E76.58.47.102
2	Daily Data	04/15/2015 01:33:23	04/15/2015 01:33:23	N11.20.18.30	E76.58.47.102
3	Daily Data	04/14/2015 01:36:23	04/14/2015 01:36:23	N11.20.17.255	E76.58.47.102
4	Daily Data	04/13/2015 01:33:23	04/13/2015 01:33:23	N11.20.18.61	E76.58.47.102
5	Daily Data	04/12/2015 01:38:23	04/12/2015 01:38:23	N11.20.18.30	E76.58.47.102
6	Daily Data	04/11/2015 01:29:23	04/11/2015 01:29:23	N11.20.33.184	E76.58.47.102

**Monthly status summary**

Category	Value
Days of Operation	7
Accumulated Monthly SMR	40.0H
Avg. SMR/Day	5.7H
Days of Movement	4

## Self-Diagnostic Monitor

Komatsu PC130-7 features an advanced diagnostics system. The Komatsu exclusive system identifies maintenance items, reduces diagnostic time, indicates oil and filter replacement hours and displays error codes.

## Continuous Machine Monitoring System

On turning ON the ignition switch, check before starting and caution indications appear on the LCD panel. If abnormalities are found, a warning lamp blinks and a warning buzzer sounds. The continuous machine condition checks help prevent the development of serious snags and allows the operator to take necessary precautions on priority.

## Abnormalities on Electronic System Display with Code

When an operational error fault occurs during operation, an error code is displayed and the caution lamp blinks and a warning buzzer sounds. This allows the operator to take necessary preventive maintenance measures.

## Oil Maintenance Function

When machine exceeds oil or filter replacement time, oil maintenance monitor lights up to inform operator.



**A.** Engine Water Temperature

**B.** Battery Charge

**C.** Engine Oil Pressure

**D.** Air Cleaner Clogging Monitor

**E.** Auto-Decel Switch

**F.** Travel Speed Select Switch

**G.** Working Mode Select Switch

**H.** Fuel Level Monitor

**I.** User or Trouble Code Display

**J.** Service Meter Display

**K.** Engine Oil Level

**L.** Engine Preheat

**M.** Swing Lock Display

**N.** Oil Maintenance

## New hybrid filter element

The new hybrid filter element in the hydraulic circuit extends the element change interval and improved filtering enhances oil life.

## Easy-to-Change Engine Oil Filter

The engine oil filter is remotely fitted for easy accessibility.

## Side-by-side cooling

Since radiator, after cooler and oil cooler are arranged in parallel, it is easy to clean, remove and install them.

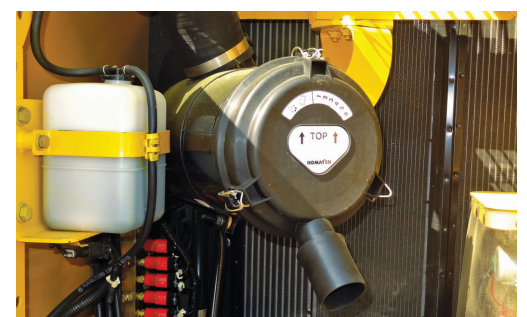



## SPECIAL VARIANTS

### Quarry Specification

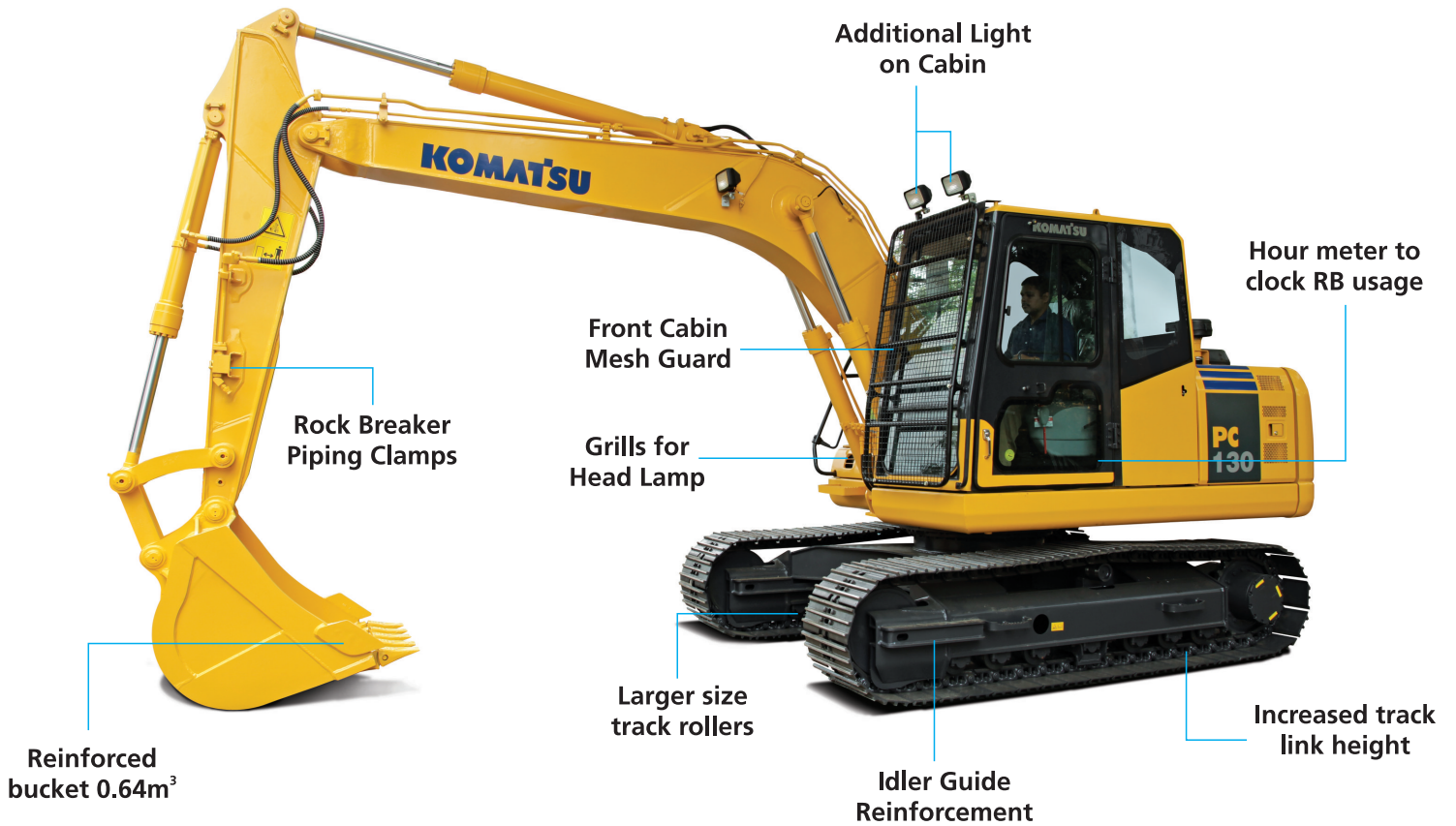

### Tunnel Specification

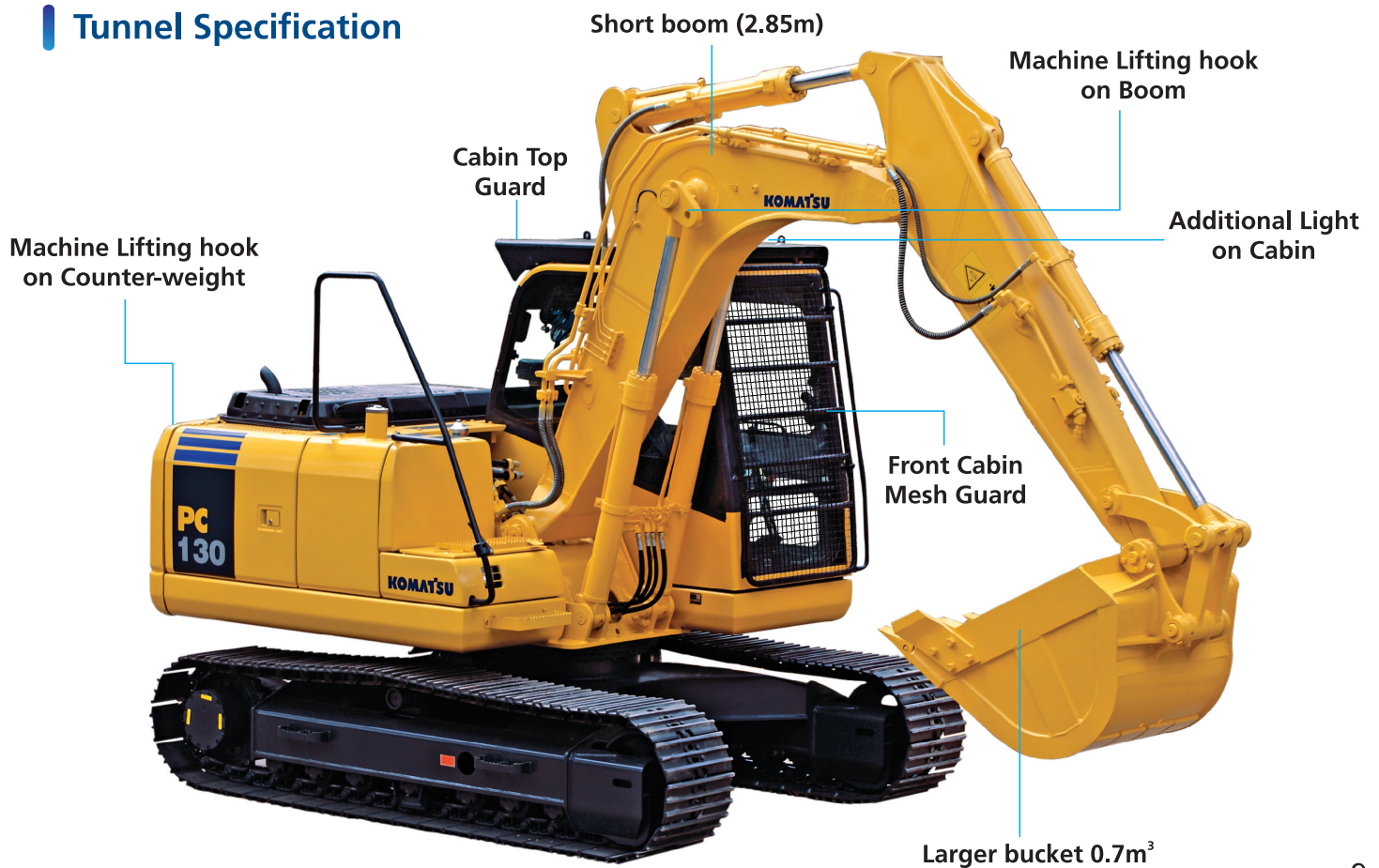

# ATTACHMENT

## Komatsu Genuine Attachment Tool

Komatsu recommends a wide range of attachment tools for Hydraulic Excavators provided to suit customer's specific applications.

### Hydraulic Breaker

Hydraulic Breaker is an attachment tool used for crushing rock beds, paved surfaces and demolishing concrete structures, etc. The large gas chamber, ideal gas pressure ratio and long-stroke piston deliver a powerful impact force. Since the breaker unit does not require an accumulator, the number of parts has been reduced, resulting in lower maintenance costs.

Komatsu Breakers deliver high impact force with every blow thus, an ideal choice for primary and second breaking.

Model type	JTHB120-3	
Working weight	kg	950
Oil flow	l/min	80~120
Operating pressure	Mpa	14~18
Impact rate	bpm	450~720
Chisel diameter	mm	∅ 105

- Accumulator-free design
- High Impact Energy
- High Reliability & Durability
- Low Operating Cost



## Komatsu Genuine Oil

### Hydraulic Oil (HO46-HM)

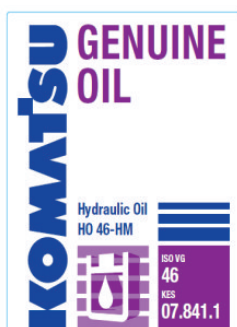

- Maintains and enhances the efficiency of the hydraulic system through high performance properties such as water separation, air release, antifoam characteristics, cleanliness and filterability
- Excellent wear protection delivered via zinc-based anti-wear additives
- Superior protection against rust and copper corrosion

### Powertrain Oil (TO30)



- Excellent protection of gears, bearings
- Very high thermal and oxidation stability
- Highly consistent and reliable friction performance which ensures minimum clutch slippage, smooth and quiet brake operation and trouble free transmission operation.

### New Diesel Engine Oil (15W-40 DH1)

- New 15W-40 DH1 Diesel Engine oil meets API CI4 Specifications
- Introducing all new high grade premium oil in India.





# SPECIFICATIONS



## ENGINE

Model .....Komatsu **SAA4D95LE-3**  
 Type ..... Water-cooled, direct injection  
 Aspiration ..... Turbocharged, after-cooled  
 Number of cylinders .....4  
 Bore ..... 95 mm 3.74"  
 Stroke ..... 115 mm 4.53"  
 Piston displacement ..... **3.26 ltr** 199 cu.in  
 Flywheel horsepower:  
 SAE J1349..... **89 HP** 66 kW @ 2200 rpm  
 DIN6270 .....90 PS 66 kW @ 2200 rpm  
 Governor .....All-speed control, mechanical

Meets 2001 EPA, EU, and Japan Tier-II emission regulations.



## HYDRAULICS

Type ..... **HydrauMind** (Hydraulic Mechanical Intelligence New Design) system, closed-center system with load sensing valves and pressure compensated valves  
 Number of selectable working modes .....4  
 Main Pump:  
 Type ..... Variable displacement piston type pumps supplying Boom, arm, bucket, swing, and travel circuits  
 Maximum flow..... **226 ltr/min** 59.7 US gal/min  
 Supply for control circuit..... Self-reducing valve  
 Hydraulic motors:  
 Travel ..... 2 x axial piston motor with parking brake  
 Swing..... 1 x axial piston motor with swing holding brake  
 Relief valve setting:  
 Implement circuits..... **31.87 MPa** 325 kgf/cm<sup>2</sup> 4,622 psi  
 Travel circuit ..... **34.81 MPa** 355 kgf/cm<sup>2</sup> 5,049 psi  
 Swing circuit ..... **28.92 MPa** 295 kgf/cm<sup>2</sup> 4,195 psi  
 Pilot circuit..... **2.94 MPa** 30 kgf/cm<sup>2</sup> 426 psi  
 Hydraulic cylinders:  
 (No of cylinders – bore x stroke x rod dia)  
 Boom..... 2 – 105 mm x 990 mm x 70 mm  
 Arm ..... 1 – 115 mm x 1175 mm x 75 mm  
 Bucket..... 1 – 95 mm x 885 mm x 65 mm



## SWING SYSTEM

Drive method ..... Hydrostatic  
 Swing circle lubrication..... Grease-bathed  
 Service brake ..... Hydraulic lock  
 Holding brake/Swing lock..... Mechanical disc brake  
 Swing speed .....0~11 rpm  
 Swing reduction .....Planetary Gear



## BACKHOE BUCKET, ARM AND BOOM COMBINATION

Application	Bucket Capacity (heaped)	Width		Weight	Number of Teeth	Arm length	
	SAE, PC SA	Without Side cutters	With Side cutters	With Side cutters		2.5 m 8'2"	2.1 m 6'10"
Heavy Duty	<b>0.53m<sup>3</sup></b> 0.69 yd <sup>3</sup>	—	908 mm 35.75"	505 kg 1113 lb	4	○	○
General Digging	<b>0.64m<sup>3</sup></b> 0.83 yd <sup>3</sup>	1000 mm 39.36"	1125 mm 44.29"	525 kg 1157 lb	5	□	○
Rock / Quarry	<b>0.64m<sup>3</sup></b> 0.83 yd <sup>3</sup>	—	1050 mm 41.34"	545 kg 1201 lb	5	□	○
Light Duty	<b>0.70m<sup>3</sup></b> 0.91 yd <sup>3</sup>	1080 mm 42.52"	1210 mm 47.64"	575 kg 1267 lb	5	□	○

These figures are based on operating conditions with maximum bucket load, maximum reach and ensured lateral stability.

○ : Material weight not over 1.8t/m<sup>3</sup> □ : Material weight not over 1.5t/m<sup>3</sup>

Tunnel Spec: Boom Length 2.85m, Arm Length 2.1m & Bucket 0.7m<sup>3</sup> (SAE) for Material density upto 1.8 t/m<sup>3</sup>

Quarry Spec: Boom Length 4.6m, Arm Length 2.1m & 0.64m<sup>3</sup> (SAE) Rock Bucket for Material density upto 1.8 t/m<sup>3</sup>



## DRIVES AND BRAKES

Steering control ..... Two levers with pedals  
 Drive method ..... Hydrostatic  
 Maximum drawbar pull ..... **100 kN** 10200 kgf 22,486 lb  
 Gradeability .....70%, 35°  
 Maximum travel speed: .....  
 High ..... **5.01 km/h** 3.11 mph  
 (Auto-Shift) Low ..... **2.70 km/h** 1.67 mph  
 Service brake .....Hydraulic lock



## UNDERCARRIAGE

Centre frame ..... X-frame  
 Track frame ..... Box-section  
 Seal of track ..... Sealed track  
 Track adjuster ..... Hydraulic  
 Number of shoes (each side) .....43  
 Number of carrier rollers..... 1 each side  
 Number of track rollers (each side)..... 7



## COOLANT AND LUBRICANT CAPACITY (REFILLING)

Fuel tank ..... **247 ltr** 65.25 U.S. gal  
 Radiator..... **13.4 ltr** 3.53 U.S. gal  
 Engine ..... **11 ltr** 2.9 U.S. gal  
 Final drive (each side)..... **2.1 ltr** 0.55 U.S. gal  
 Swing drive ..... **2.5 ltr** 0.66 U.S. gal  
 Hydraulic tank ..... **90 ltr** 23.77 U.S. gal



## OPERATING WEIGHT (APPROXIMATE)

Operating weight including 4.6 m 15'1" one-piece boom, 2.1 m 6'10" arm, SAE heaped 0.64 m<sup>3</sup> 0.83 yd<sup>3</sup> bucket capacity, lubricants, coolant, full fuel tank, operator and standard equipment.

KOMATSU PC130-7		
Shoes	Operating Weight	Ground Pressure
500 mm	12,600 kg	0.39 kg/cm <sup>2</sup>
600 mm	12,780 kg	0.34 kg/cm <sup>2</sup>



## MACHINE DIMENSIONS

	Arm Length	2100 mm	2500 mm
A	Length on ground (transporting)	7590 mm	7595 mm
B	Overall height (top to bottom)	2620 mm	2810 mm
C	Width of upper structure	2490 mm	2490 mm
D	Total height (to top of cabin)	2810 mm	2810 mm
E	Overall length of basic machine	3985 mm	3985 mm
F	Distance from swing center to tail	2170 mm	2170 mm
G	Clearance under counterweight	855 mm	855 mm
H	Counterweight height	1885 mm	1885 mm
I	Minimum ground clearance	400 mm	400 mm
J	Track length on ground	2880 mm	2880 mm
K	Track length	3610 mm	3610 mm
L	Track gauge	1990 mm	1990 mm
M	Width of track shoe	500 mm	500 mm
N	Overall track width	2490 mm	2490 mm

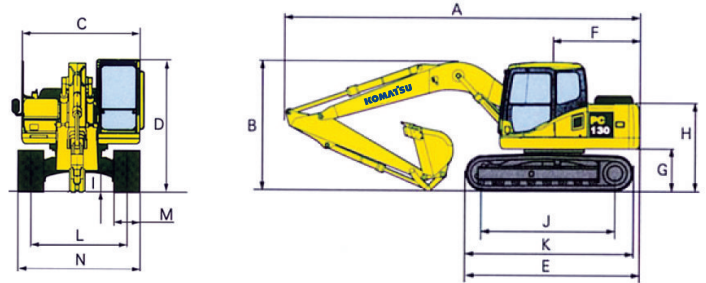

## LIFTING CAPACITY

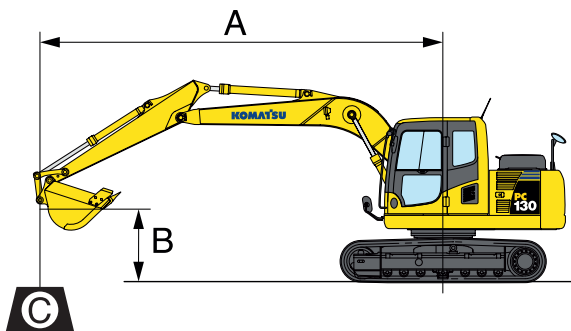

- A : Reach for swing centre
- B : Bucket height
- C : Lifting Capacity
- Cf : Rating over front
- Cs : Rating over side
- ⊗ : Rating at maximum reach

Conditions:

- 4600 mm 15'1" one-piece boom
- 0.64 m<sup>3</sup> 0.83 yd<sup>3</sup> SAE heaped bucket
- 500 mm 20" triple-grouser shoe
- 2.1m Arm

Unit kg & lb

Reach A B Height	Max. Reach ⊗		6 m		4.5 m		3 m		1.5 m	
	Cf	Cs	Cf	Cs	Cf	Cs	Cf	Cs	Cf	Cs
6 m 19' 8"	2600 * 5730*	2350 5180			3150 * 6940*	3050 6720				
4.5 m 14' 9"	2400 * 5290*	1650 3530	2600 5730	1750 3860	3300 * 7280*	3000 6610				
3 m 9' 10"	2050 4520	1350 2960	2600 5730	1700 3750	4000 * 8820*	2850 6280	5600 * 12350*	5600 * 12350*		
1.5 m 4' 11"	1900 4190	1200 2650	2500 5510	1600 3530	4000 8820	2600 5730	6300 * 13890*	4850 10690		
0 m	1950 4300	1250 2760	2400 5290	1500 3310	3800 8380	2400 5290	5800 * 12880*	4500 9920		
-1.5 m -4' 11"	2200 4850	1400 3090	2350 5180	1500 3310	3700 8160	2350 5180	5850 * 12900*	4450 9810	5450 * 12020*	5450 * 12020*
-3 m -9' 10"	2900 6390	1850 4080			3750 8270	2350 5180	6400 * 14110*	4550 10030	5800 * 12790*	5800 * 12790*

\* Load is limited by hydraulic capacity rather than tipping.

Ratings are based on SAE Standard No. J1097.

Rated loads do not exceed 87% of hydraulic lift capacity or 75% of tipping load.



M E M O

-----

-----

-----

-----

-----

-----

-----

-----

-----

-----

-----

-----

-----

-----

-----

-----

-----

-----

-----

-----

-----

-----

-----

-----

-----

-----

-----

-----

-----

-----



## WORKING RANGE

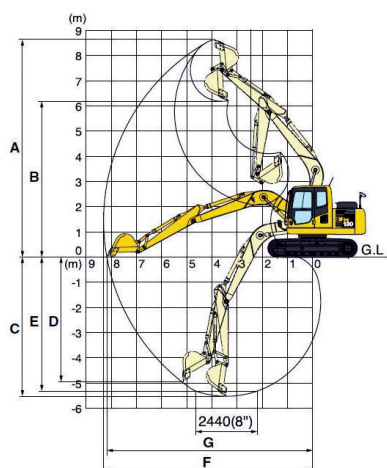

	Arm Types	2.1 m	2.5 m	2.1 m (Tunnel)
A	Maximum digging height	8345 mm	8610 mm	6085 mm
B	Maximum dumping height	5905 mm	6170 mm	3908 mm
C	Maximum digging depth	5115 mm	5520 mm	3707 mm
D	Maximum vertical wall digging depth	4520 mm	4940 mm	-
E	Maximum digging depth of cut for 8' level	4875 mm	5315 mm	-
F	Maximum digging reach	7925 mm	8290 mm	5883 mm
G	Maximum digging reach at ground level	7795 mm	8170 mm	5706 mm
	Bucket digging force (ISO)	86.29 kN	86.29 kN	86.29 kN
	Bucket maximum digging force (ISO)	93.16 kN	93.16 kN	93.16 kN
	Arm crowd force (ISO)	70.60 kN	61.78 kN	70.60 kN
	Arm maximum crowd force (ISO)	77.47 kN	67.66 kN	77.47 kN



## STANDARD EQUIPMENT

- 2-speed hydrostatic travel system with planetary gear unit and hydraulic brake disc
- 4 working mode selection system; active mode, economy mode, breaker mode and lifting mode
- 500mm triple grouser track
- Adjustable suspension seat
- Alternator 24V/35A
- Arm 2100 mm
- Auto deceleration function
- Battery 2 x 12V/65Ah
- Boom safety valves
- Corrosion resistor
- Double-element air cleaner with dust indicator and automatic dust evacuator
- Electric horn
- Electronic closed centre load sensing (E-CLSS) hydraulic system (HydrauMind)
- Engine overheat prevention system
- Engine stop key
- Fan guard structure
- Fuel control dial
- Komatsu SAA4D95LE-3, 66 kW direct injection, after-cooled, turbocharged engine
- Large handrails and rear view mirror
- Lockable fuel tank cap and cover
- Monitor panel – 7 segment
- One piece boom 4600 mm
- Power Max function
- PPC control levels and pedals for steering and travelling
- Pre-Fuel Filter
- Spare parts catalogue and operation/ maintenance manual
- Standard counterweight
- Standard signs (labels)
- Starter motor 24V/3.0kw
- Toolkit
- Track roller – 7 each side
- Water separator
- Working lights – 2 (Boom & RH)



## OPTIONAL EQUIPMENT

- Air-Cooler
- Bolt on top and front guard (Operator protective guard)
- Rock Breaker adaptation kit
- Service valve
- Arm 2500mm
- 600mm triple grouser track

Product improvement is a continuous process. Specifications given in this publication are therefore subject to change without notice. Photographs depicted may be of optional equipment

www.Komatsu.com

11.2017

**KOMATSU**<sup>®</sup>



Marketed & Serviced by:

**L&T Construction Equipment**

**Larsen & Toubro Limited**

1<sup>st</sup> Floor Lakshminarayan Complex, 10/1 Palace Road, Bengaluru- 560 052  
Tel: (080) 22256982/83/84, 40401700 Fax: (080) 22250309  
E-mail: ceb@larsentoubro.com www.larsentoubro.com

**Zonal Offices:**

**Delhi** (011) 4141 9555/59  
**Nagpur** (0712) 6606441/2260025

**Kolkata** (033) 44002433/22831442  
**Hyderabad** (040) 23230206/67015064

**Pune** (020) 66033483/480  
**Chennai** (044) 22706865/22706850

CIN: L99999MH1946PLC004768

Materials and specifications are subject to change without notice.

**KOMATSU** is a trademark of Komatsu Ltd. Japan.